



TEKIRO

TEKIRO  
TOOL BOX

TEKIRO

TEKIRO

TE-10002



**STORAGE**



## CABINET 3 DRAWER

ITEM CODE	SIZE	1 (mm)	2 (mm)	3 (mm)	4 (mm)	5 (mm)	6 (mm)	7 (mm)	WEIGHT (gr)	QTY / BOX INNER/MASTER
ST-CA1062	TBI 4003X	669	503	315	266	46	75	100	14,700	1 box @ 1 pcs

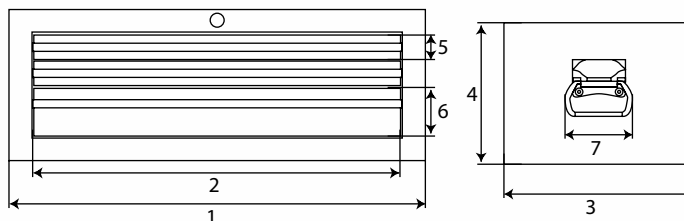

## CABINET 4-1 DRAWER

- All steel for strength and durability
- Full bearing drawer slides for smooth operatio
- High load capacity

ITEM CODE	SIZE	1 (mm)	2 (mm)	3 (mm)	4 (mm)	5 (mm)	6 (mm)	7 (mm)	WEIGHT (gr)	QTY / BOX INNER/MASTER
SR-CA1834	61 x 31 x 38cm	660	593	307	377	74.5	48	193.5	21,500	1 box @ 1 pcs

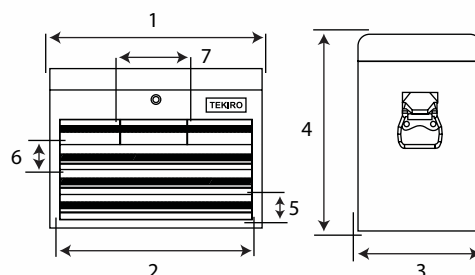

## CABINET 6 DRAWER

ITEM CODE	SIZE	1 (mm)	2 (mm)	3 (mm)	4 (mm)	5 (mm)	6 (mm)	7 (mm)	WEIGHT (gr)	QTY / BOX INNER/MASTER
ST-CA1063	TBT 4006E	660	593	307	377	75	48	195	21,500	1 box @ 1 pcs

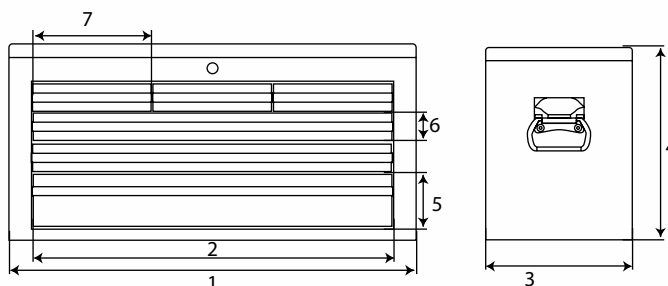





# TEKIRO®



SCREWDRIVER



AUTOMOTIVE



STORAGE



TRAY



## ROLLER CABINET 4 DRAWER



ITEM CODE	SIZE	1 (mm)	2 (mm)	3 (mm)	4 (mm)	5 (mm)	6 (mm)	7 (mm)	WEIGHT (gr)	QTY / BOX INNER/MASTER
ST-RC1064	TBI 3003	849	688	457	264	153	100	612	38,000	1 box @ 1 pcs

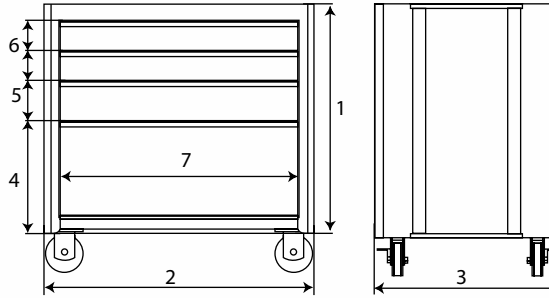

## ROLLER CABINET 7 DRAWER



ITEM CODE	SIZE	1 (mm)	2 (mm)	3 (mm)	4 (mm)	5 (mm)	6 (mm)	7 (mm)	WEIGHT (gr)	QTY / BOX INNER/MASTER
ST-RC1065	TBI 3007	850	672	450	210	110	50	610	47,000	1 box @ 1 pcs

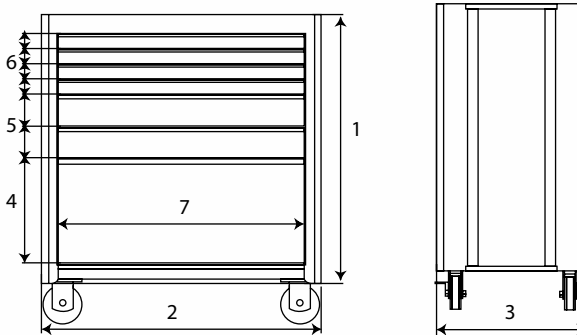

## TOOL CART

- Ball-bearing drawer slides for smooth movement
- Full extension removable drawers
- High quality material
- Specially developed for car/motorcycle mechanics
- Chest and the like can be placed on top

ITEM CODE	SIZE	1 (mm)	2 (mm)	3 (mm)	4 (mm)	5 (mm)	6 (mm)	7 (mm)	8 (mm)	9 (mm)	WEIGHT (gr)	QTY / BOX INNER/MASTER
SR-TC1832	69 X 47 X 89	890	750	680	80	200	280	580	680	460	22,000	1 box @ 1 pcs

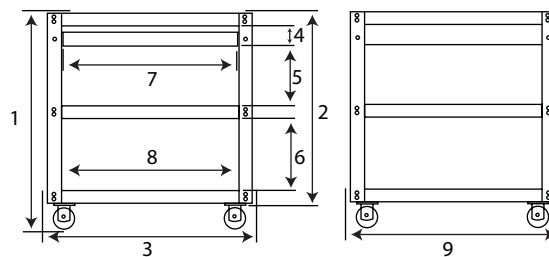



- Material : Polypropylene with ABS handle & buckle
- Shock resistance
- Loading capacity 30 kg

## TOOL BOX 0201 (PLASTIC)

ITEM CODE	SIZE	1 (mm)	2 (mm)	3 (mm)	WEIGHT (gr)	QTY / BOX INNER/MASTER
ST-TB1069	TB901	380	139	169	890	1 / 10 pcs

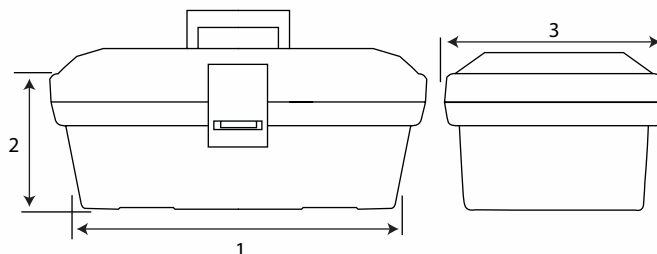

- Material : Polypropylene with ABS handle & buckle
- Shock resistance
- Loading capacity 30 kg



## TOOL BOX 0210 (PLASTIC)

ITEM CODE	SIZE	1 (mm)	2 (mm)	3 (mm)	WEIGHT (gr)	QTY / BOX INNER/MASTER
ST-TB1070	TB902	440	200	226	1,680	1 / 6 pcs

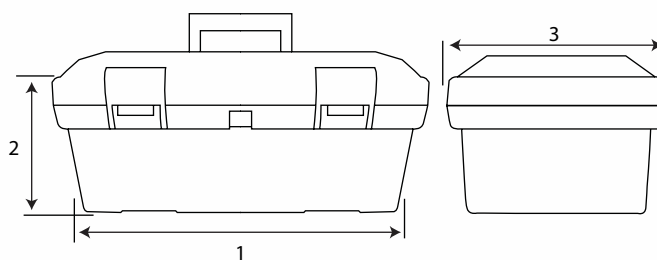

- Material : Polypropylene with ABS handle & buckle
- Shock resistance
- Loading capacity 30 kg

## TOOL BOX 0205 (PLASTIC)

ITEM CODE	SIZE	1 (mm)	2 (mm)	3 (mm)	WEIGHT (gr)	QTY / BOX INNER/MASTER
ST-TB1071	TB905	410	204	226	1,980	1 / 6 pcs

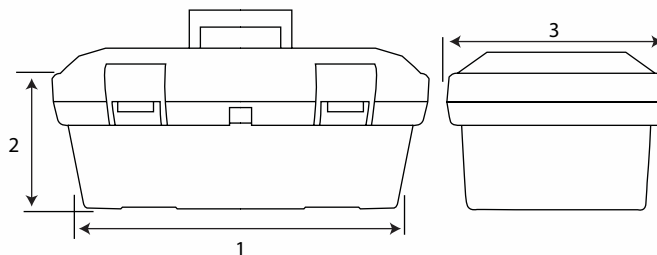

- Material : Polypropylene with ABS handle & buckle
- Shock resistance
- Loading capacity 30 kg

## TOOL BOX 02800 (PLASTIC)

ITEM CODE	SIZE	1 (mm)	2 (mm)	3 (mm)	WEIGHT (gr)	QTY / BOX INNER/MASTER
ST-TB1072	TB800	481	268	238	2,360	1 / 4 pcs

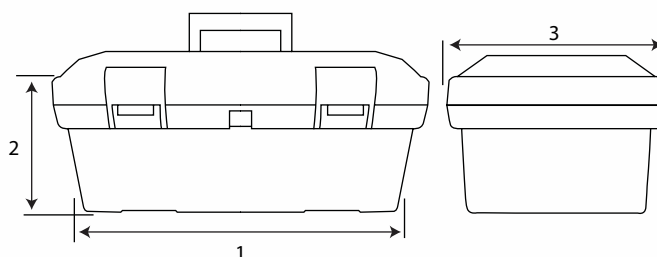



## TOOL BOX WITH 1 TIER

- Lock hook for safety
- Strong hinge

ITEM CODE	SIZE	1 (mm)	2 (mm)	3 (mm)	WEIGHT (gr)	QTY / BOX INNER/MASTER
ST-TB1067	T-325	355	115	145	1,060	1 / 12 pcs
ST-TB1066	T-528	410	125	150	1,310	1 / 12 pcs

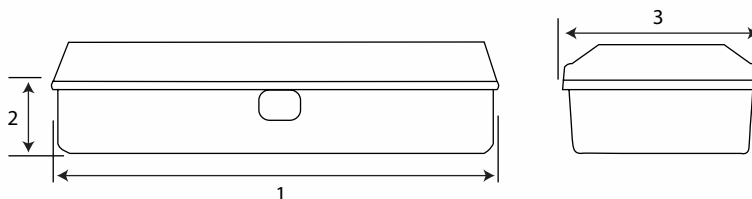

## TOOL BOX WITH 3 TIER

- Lock hook for safety
- Strong hinge

ITEM CODE	SIZE	1 (mm)	2 (mm)	3 (mm)	4 (mm)	5 (mm)	6 (mm)	7 (mm)	WEIGHT (gr)	QTY / BOX INNER/MAS-TER
ST-TB1068		555	119	50	200	231	300	500	4,760	1 pcs

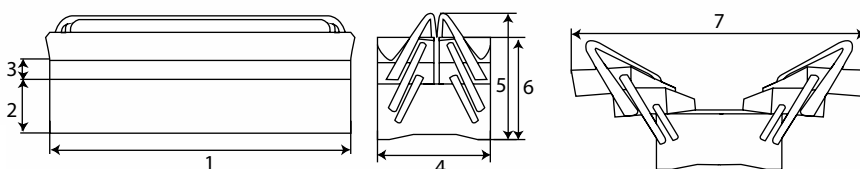

## TOOL BAG



ITEM CODE	SIZE	1 (mm)	2 (mm)	3 (mm)	WEIGHT (gr)	QTY / BOX INNER/MASTER
ST-BA1073	39 X 8 X 11 cm	390	150	70	111	1 box = 250 pcs

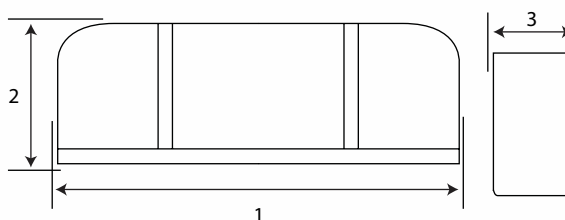





SCREWDRIVER



AUTOMOTIVE



STORAGE



TRAY



### SPECIAL FEATURES

- One plate no welding
- Have ball bearing, it can make easier when customer want to open although the rack is fully charged with tools
- Board on the top, thickness is 20 mm
- Thickness plate the top and bottom until 1,2 mm and the drawers 1 mm
- Drawers loading test until 3.000 kg
- TPR Wheel reduce the noise when the cabinet want to move to another place

## TOOLS TROLLEY 3 DRAWER

### TROLI 3 LACI ISI

ITEM CODE	SIZE	1 (mm)	2 (mm)	3 (mm)	4 (mm)	5 (mm)	WEIGHT (gr)	QTY / BOX INNER/MASTER
ST-RC1590		650	710	490	470	230	52,000	1 pcs

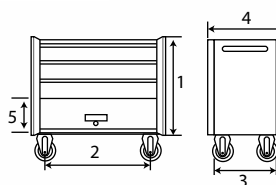

### SPECIAL FEATURES

- One plate no welding
- Have ball bearing, it can make easier when customer want to open although the rack is fully charged with tools
- Board on the top, thickness is 20 mm
- Thickness plate the top and bottom until 1,2 mm and the drawers 1 mm
- Drawers loading test until 3.000 kg
- TPR Wheel reduce the noise when the cabinet want to move to another place

## TOOLS TROLLEY 5 DRAWER

### TROLI 5 LACI

ITEM CODE	SIZE	1 (mm)	2 (mm)	3 (mm)	4 (mm)	5 (mm)	WEIGHT (gr)	QTY / BOX INNER/MASTER
ST-RC1589		800	710	500	460	150	70,000	1 pcs

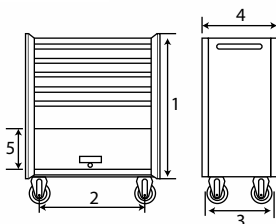

### SPECIAL FEATURES

- One plate no welding
- Have ball bearing, it can make easier when customer want to open although the rack is fully charged with tools
- Board on the top, thickness is 20 mm
- Thickness plate the top and bottom until 1,2 mm and the drawers 1 mm
- Drawers loading test until 3.000 kg
- TPR Wheel reduce the noise when the cabinet want to move to another place

## TOOLS TROLLEY 5 DRAWER BLACK

### TROLI 5 LACI HITAM ISI

ITEM CODE	SIZE	1 (mm)	2 (mm)	3 (mm)	4 (mm)	5 (mm)	WEIGHT (gr)	QTY / BOX INNER/MASTER
ST-RC1650		640	590	480	436	230	66,500	1 pcs

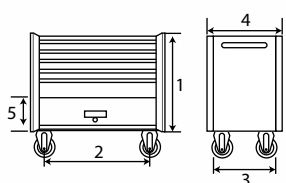

### SPECIAL FEATURES

- One plate no welding
- Have ball bearing, it can make easier when customer want to open although the rack is fully charged with tools
- Board on the top, thickness is 20 mm
- Thickness plate the top and bottom until 1,2 mm and the drawers 1 mm
- Drawers loading test until 3.000 kg
- TPR Wheel reduce the noise when the cabinet want to move to another place

## TOOLS TROLLEY 7 DRAWER

### TROLI 7 LACI

ITEM CODE	SIZE	1 (mm)	2 (mm)	3 (mm)	4 (mm)	5 (mm)	WEIGHT (gr)	QTY / BOX INNER/MASTER
ST-RC1501		800	710	500	460	150	78,000	1 pcs

