

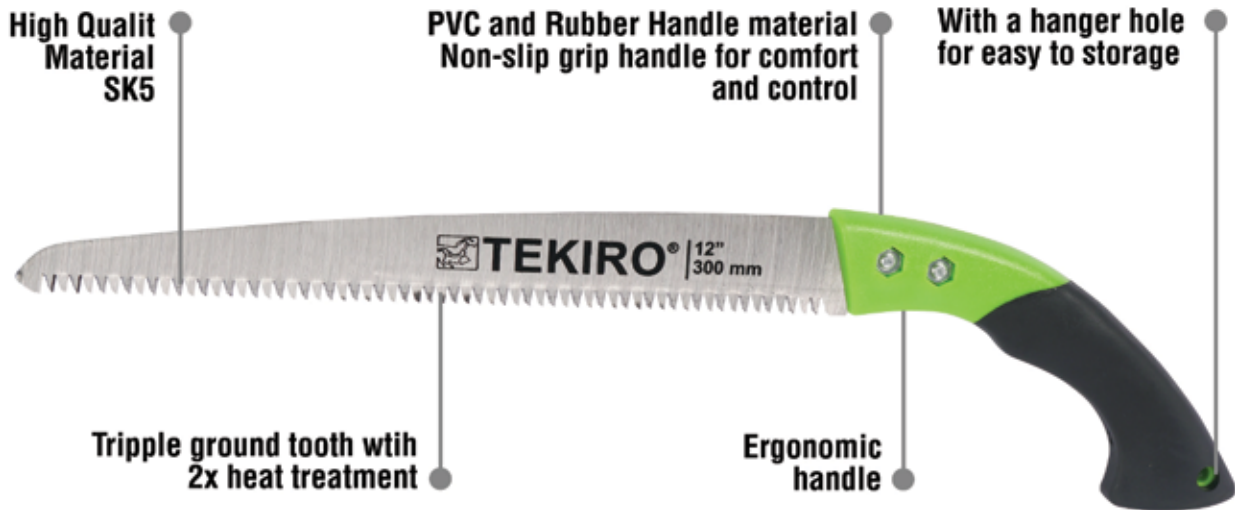

## GARDENING TOOLS

**TEKIRO** has a range of gardening tools which includes Pruning Saw, Pruning Shears and Multifunction Scissors are ideal for gardening hobbyists and professionals. Our ergonomic design combined with quality manufacturing ensure that everyday gardening is easy and enjoyable.



- ERGONOMIC HANDLE**  
 The ergonomic handle and slightly angled handle shape and soft handle parts allow the saw to lie comfortably and safely in your hand.
- EFFORT-SAVING SAWING**  
 Outstanding ergonomics, high-quality materials (SK5) provide great sawing performance with little effort ensure easy sawing.
- SMOOTH CUT**  
 The high quality material, triple teeth saw blade, impulse-hardened teeth cuts branches with precision. Starting a saw cut is considerably easier.



## PRUNING SAW

GERGAJI DAHAN

ITEM CODE	SIZE	1 (mm)	2 (mm)	3 (mm)	4 (mm)	5 (mm)	WEIGHT (gr)	QTY / BOX INNER/MASTER
GT-PS1715	12"	476	310	191	21	36	225	10 / 60 pcs

- Comfort & anti slip grip
- Sharp and precise edge
- Can be use for most type of wood
- Quick cut high strength blade
- The blade features super sharp teeth for more aggressive and faster cutting
- Tripple ground tooth

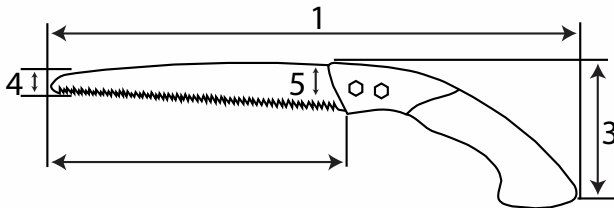

## PRUNING SHEAR CURVED

GUNTING DAHAN BENGKOK

ITEM CODE	SIZE	1 (mm)	2 (mm)	3 (mm)	4 (mm)	WEIGHT (gr)	QTY / BOX INNER/MASTER
GD-PS1782	8"	207	52	85	85	269	10 / 60 pcs

- Heavy duty pruning shears with soft grips
- Ideal for pruning bonsai, dead heading, thinning of soft stem branches, shrubs and flower stems
- Curved stainless steel blades hardened and tempered

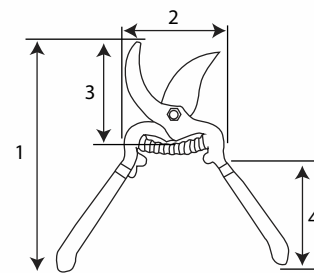
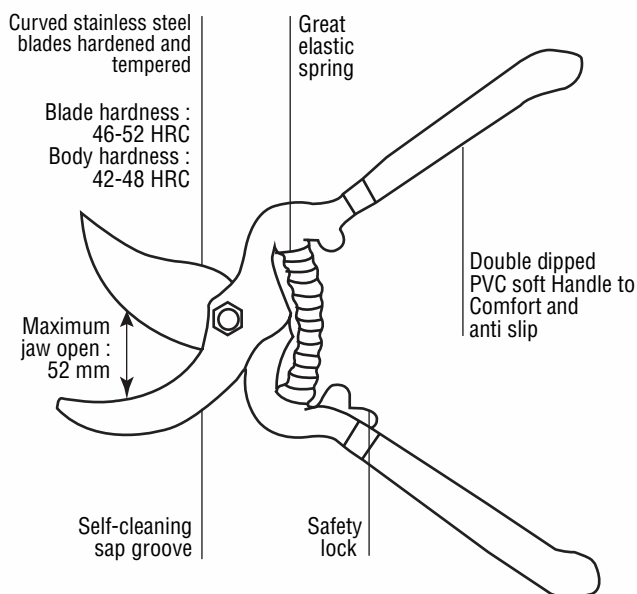

- Heavy duty pruning shears with soft grips
- Ideal for pruning bonsai, dead heading, thinning of soft stem branches, shrubs and flower stems
- Straight stainless steel blades hardened and tempered

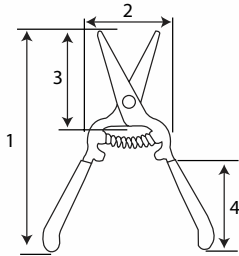

## PRUNING SHEAR STRAIGHT

### GUNTING DAHAN LURUS

ITEM CODE	SIZE	1 (mm)	2 (mm)	3 (mm)	4 (mm)	WEIGHT (gr)	QTY / BOX INNER/MASTER
GD-PS1780	6"	150	38	65	60	132	10 / 100 pcs
GD-PS1781	8"	202	44	85	77	209	10 / 60 pcs

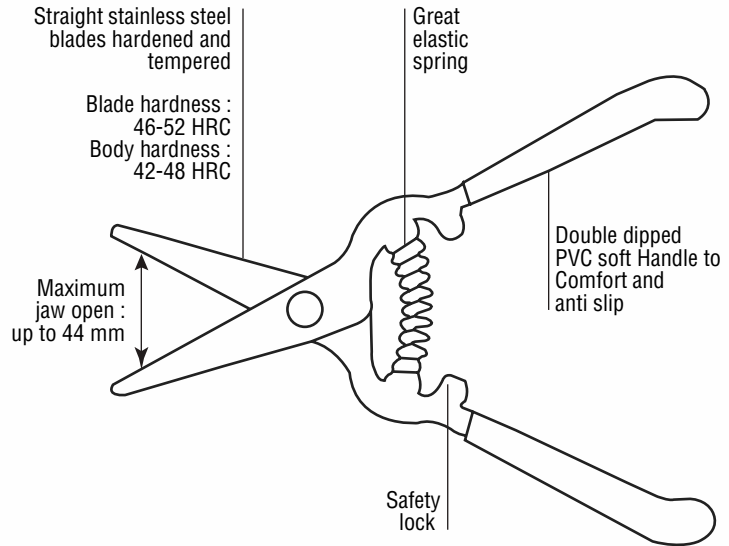

- Made of high-carbon stainless steel, corrosion-resistant
- Dentate slip design, sharp knife, better cutting effect
- The non-slip grip

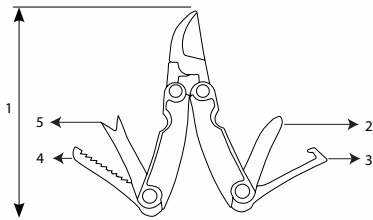

## MULTIFUNCTION SCISSOR 6 IN 1

### GUNTING MULTIFUNGS1 6 IN 1

ITEM CODE	SIZE	1 (mm)	2 (mm)	3 (mm)	4 (mm)	5 (mm)	WEIGHT (gr)	QTY / BOX INNER/MASTER
GT-MS1708	145 mm	145	56	55	57.4	56	201	6 / 72 pcs

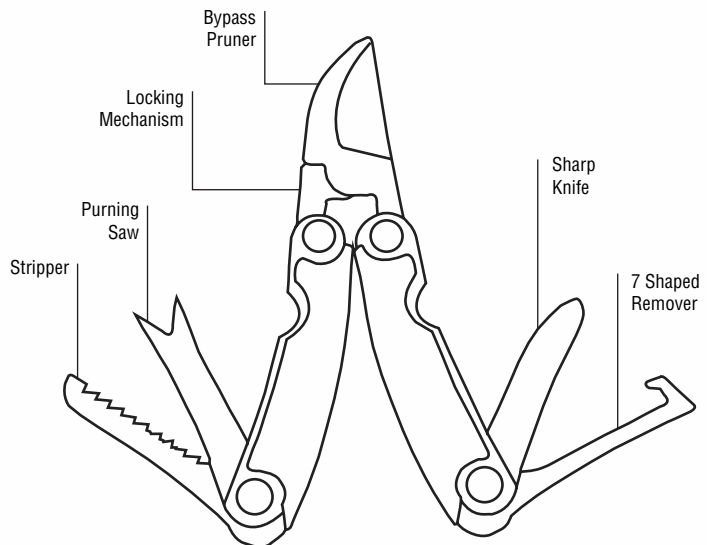

**BELIEVE**  
**IN YOUR CHOICE**

**WWW.TEKIRO.COM**